

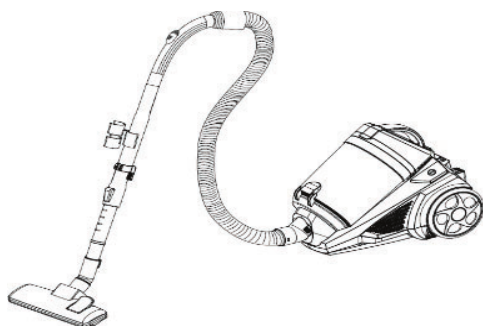

**REVO RED BAGLESS CANISTER VACUUM  
OWNER'S MANUAL**

**Model: AHC-RR**

**120V 60Hz, 1400W ETL US Canada**



**Atrix**

**1350 Larc Industrial Blvd.**

**Burnsville, MN 55337**

**[www.atrix.com](http://www.atrix.com)**

**[sales@atrix.com](mailto:sales@atrix.com)**

**Telephone: 952.894.6154**

**Toll Free Telephone: 800.222.6154**

**Fax: 952.894.6256**

## **IMPORTANT SAFETY INSTRUCTIONS**

When using an electrical appliance, basic precautions should always be followed, including the following:

### **READ ALL INSTRUCTIONS BEFORE USING APPLIANCE**

#### **WARNING: TO REDUCE THE RISK OF FIRE, ELECTRICAL SHOCK OR INJURY:**

1. Do not leave appliance when plugged in. Unplug from outlet when not in use and before servicing.
2. Electrical shock may occur if used outdoors or on wet surfaces.
3. Do not allow to be used as a toy. Close attention is necessary when used by or near children.
4. Use only as described in this manual. Use only manufacturer's recommended instructions.
5. Do not use with damaged cord or plug. If appliance is not working as it should, has been dropped, damaged, left outdoors, or dropped into water, return to Atrix International.
6. Do not pull or carry by cord, use cord as a handle, close a door on cord, or pull cord around sharp edges of corners. Do not run appliance over cord. Keep cord away from heated surfaces.
7. Do not unplug by pulling on cord. To unplug, grasp plug, not the cord.
8. Do not handle plug or appliance with wet hands.
9. Do not put any object into any openings. Do not use with any opening blocked; keep free of dust, lint, hair, and anything that may reduce airflow.
10. Keep hair, loose clothing, fingers and all body parts away from openings and moving parts.
11. Do not pick up anything that is burning or smoking such as cigarettes, matches or hot ashes.
12. Do not use without filter in place.

13. Turn off all controls before unplugging.
14. Use extra care when cleaning on stairs.
15. Do not use to pick up any liquids, including flammable or combustible liquids such as gasoline or use in areas where they may be present.
16. Connect to a properly grounded outlet only.
17. This appliance is not intended for use by persons (including children) with reduced physical, sensory and mental capabilities, or lack of experience and knowledge, unless they have been given supervision or instruction concerning use of appliance by person responsible for their safety.
18. Children should be supervised to ensure that they do not play with the appliance.

**SAVE THESE INSTRUCTIONS!**

## Components and Equipment

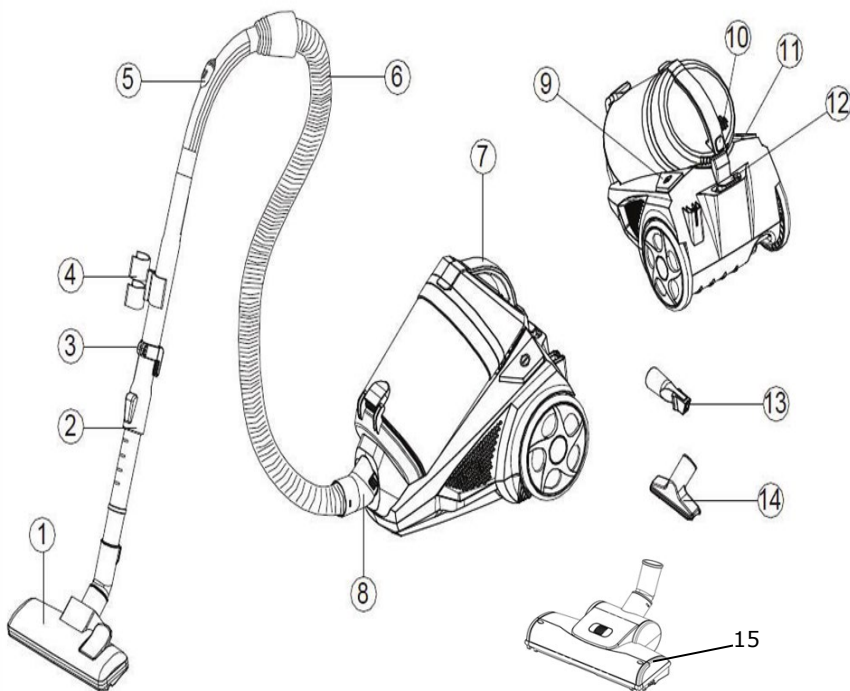

1. Floor Tool
2. Telescopic Wand
3. Parking Fixture
4. Storage Clip
5. Air Slide
6. Vacuum Hose
7. Carrying Handle
8. Vacuum Hose Connection

9. ON/OFF Button
  10. Release Button
  11. Cord Rewind Button
  12. Motor Power Adjustment Slide
  13. Crevice Nozzle
  14. Upholstery Nozzle
  15. Turbo Brush
- NOT PICTURED: Oval Dust Brush

## Preparing and Assembling the Revo Red

1. Fit the hose on the vacuum cleaner by inserting the rotating hose connection into the vacuum cleaner until you hear a click. To remove the hose, press the button at the side of the hose connection and then pull it out.



2. Fit the telescopic tube into the other end of the hose.

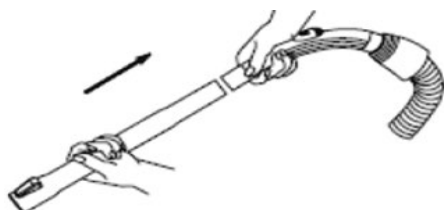

3. Adjust the length of the telescopic tube by pushing the locking mechanism down and pulling in the bottom section of the tube to a suitable length. When parking, shorten the tube as far as possible.



4. Fit the floor brush into the telescope tube.

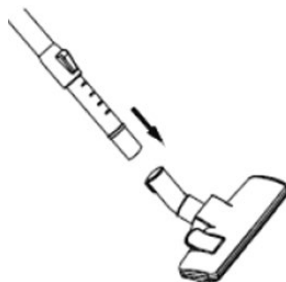

## Floor Nozzle

The floor nozzle has two settings. When cleaning hard surfaces (wood, tile etc.), the brush bristles should be extended. When cleaning carpets and mats, the brush bristles should be retracted into the nozzle. Press the brush change button to switch between the two settings.

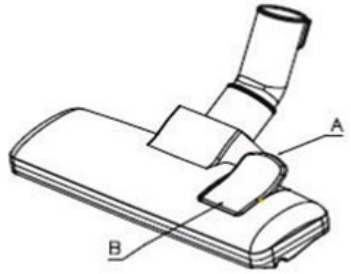

## Crevice Nozzle

For radiators, corners, base boards, etc.



## Upholstery Nozzle

For furniture, curtains, drapes, etc.



## Using the Revo Red

1. Before using the vacuum, pull out a sufficient length of cord and then plug the cleaner into the wall outlet.
2. The yellow mark on the cord is the maximum length and must not be exceeded.

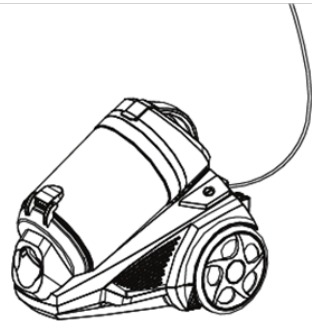

3. Push On/Off Button



4. To rewind the cord, push cord rewind button



## Emptying the Revo Red Dust Bin

1. Empty the dust bin regularly, at the latest when the quantity of dirt in the dust container has reached the "MAX" mark or the suction power has dropped.
2. Switch off the vacuum cleaner and disconnect the plug from the outlet. To do this, always pull on the plug and not on the cord.
3. Release the dust container by pressing down the release button (Fig. 1).

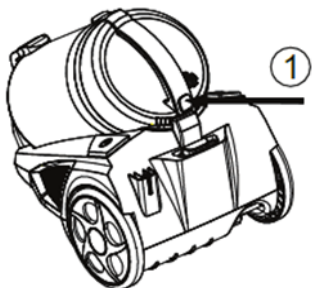

4. Lift the dust container forwards out of the cylinder vacuum cleaner (Fig. 2).

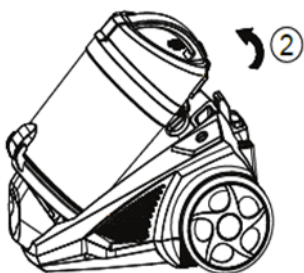

5. When emptying the dust container, hold it low over the garbage can.
6. Press the open button. The base opens and the dust drops (Fig. 3).

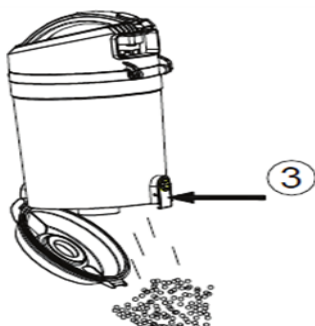

7. Carefully knock the remaining dust loose.
8. Close the base.
9. Place the dust bin back onto the vacuum cleaner.
10. Check whether the dust container is securely seated.

### **Cleaning the Revo Red HEPA and Foam Filters**

1. Turn off and unplug cleaner.
2. Remove the dust bin.
3. Open the dust bin cover and remove filters.
4. For a quick clean, tap on side of garbage can.
5. For a deep clean, rinse with water and dry.
6. Insert the dry filters back into the dust bin cover.
7. To deep clean dust bin and chamber, twist and unlock from assembly.
8. Rinse with water and dry.
9. Reassemble and attach to vacuum.
10. Check whether the dust bin is securely seated.

**IMPORTANT!** Never use the vacuum cleaner without filters.

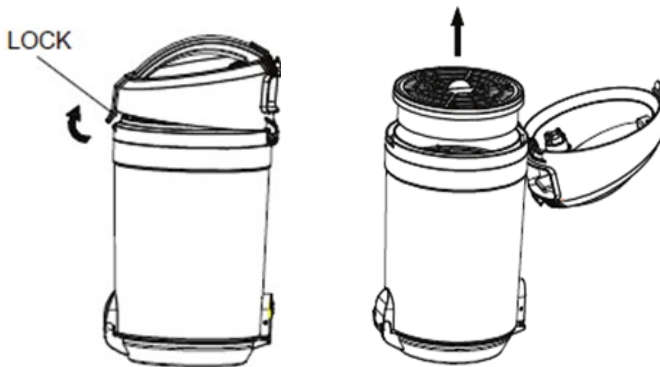



## Cleaning the Revo Red Intake and Exhaust Filters

The intake/exhaust air foam filters will rarely require cleaning. You can use the same wet or dry method as described above. Turn off. Unplug. Remove. Clean. Dry. Install.

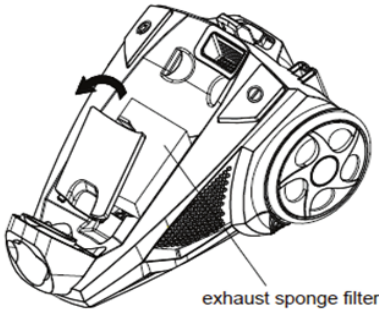

## Cleaning the Revo Red

1. Unplug the vacuum cleaner.
2. Wipe with a slightly damp cloth.
3. Do NOT use any form of strong, solvent or abrasive cleaners.
4. Let dry before next use.

## Disposal Information



Waste electrical products should not be disposed of with household waste. Please recycle where facilities exist. Check with your local authority for recycling advice.



## **ATRIX REVO RED BAGLESS CANISTER VACUUM WARRANTY INFORMATION**

**Warranty/Service Information: For warranty service information, please contact Atrix or your local Atrix distributor.**

Atrix Revo Red Bagless Canister Vacuum Limited Warranty: To the original user purchasing the Atrix Rego Red Bagless Canister Vacuum, Atrix warrants that the vacuum will be free of defects in material and manufacture for a period of one (1) year from the date of purchase. Should any failure to conform to this warranty appear within this period, Atrix will, at its option, repair or replace the defective product. It is the user's responsibility to return the product, freight prepaid, to Atrix International. These remedies are the user's exclusive remedies for breach of this warranty.

**Exclusions to warranty coverage:** The above warranty will not apply to any special configurations or to any units that have been modified, or damaged by negligence, misuse, accident or failure to follow Atrix's Instruction Manual. Consumable supplies, such as filters, accessories, and motor brushes are not covered by this warranty.

**Disclaimer of Warranty:** EXCEPT FOR THE IMPLIED WARRANTIES OF TITLE AND AGAINST PATENT INFRINGEMENT, ATRIX MAKES NO OTHER WARRANTIES WITH RESPECT TO THE ATRIX CANISTER VACUUM CLEANER, EXPRESS OR IMPLIED, INCLUDING BUT NOT LIMITED TO ANY IMPLIED WARRANTY OF MERCHANTABILITY OR FITNESS FOR A PARTICULAR PURPOSE.

**Limitation of Liability:** ATRIX WILL NOT BE LIABLE UNDER ANY CIRCUMSTANCES FOR ANY COINCIDENTAL, SPECIAL, OR CONSEQUENTIAL DAMAGES OR ECONOMICAL LOSS, BASED UPON BREACH OF WARRANTY, BREACH OF CONTRACT, NEGLIGENCE, STRICT LIABILITY IN TORT OR ANY OTHER LEGAL THEORY, EVEN IF ATRIX HAS BEEN ADVISED OF THE POSSIBILITY OF SUCH DAMAGES INCLUDING, BUT NOT LIMITED TO LOSS OF PROFITS, REVENUE, EQUIPMENT USE, DATA OR INFORMATION OF ANY KIND. THE LIABILITY OF ATRIX SHALL NOT UNDER ANY CIRCUMSTANCE, EXCEPT AS EXPRESSLY PROVIDED HEREIN, EXCEED THE PRICE OF THE ATRIX CANISTER VACUUM.

**To Register your Warranty Visit:**

**[www.atrix.com](http://www.atrix.com)**